

# AT100

Smart Treadmill





# Table of Contents

<b>1</b>	<b>Important Notice.....</b>	<b>1</b>
<b>2</b>	<b>Safety Precautions.....</b>	<b>2</b>
<b>3</b>	<b>Assembly.....</b>	<b>4</b>
3.1	Parts List .....	7
3.2	Placement of the Equipment.....	7
3.3	Assemble Steps.....	9
3.4	Folding and Moving Guideline.....	15
<b>4</b>	<b>Preparation .....</b>	<b>17</b>
<b>5</b>	<b>Control Panel &amp; Display Window .....</b>	<b>19</b>
5.1	Keys.....	19
5.2	Data Fields .....	20
5.3	Pairing with NFC .....	22
5.4	Heart Rate Zone Indicator .....	23
5.5	Sport Mode.....	24
5.5.1	Select a Workout or Target .....	30
5.5.2	Quick Start .....	31
5.6	Application and Compatibility .....	32
<b>6</b>	<b>Maintenance .....</b>	<b>35</b>
<b>7</b>	<b>Belt Adjustment .....</b>	<b>36</b>
7.1	Center the Belt .....	36
7.2	Adjusting Belt Tension .....	37
<b>8</b>	<b>Lubrication .....</b>	<b>38</b>
<b>9</b>	<b>Specification.....</b>	<b>39</b>
<b>10</b>	<b>Appendix .....</b>	<b>40</b>
10.1	Exploded View .....	40

# 1 Important Notice

## Please keep this manual in good condition

- Please thoroughly read and follow the instructions for assembling or using the equipment. If you have any questions please contact your local distributor or visit our website: [ATTACUSfitness.com](https://ATTACUSfitness.com).
- For your safety, please take safety measures and follow the instructions. Keep this manual in good condition for future reference.
- The owner of the equipment has the sole responsibility ensuring that all the instructions and safety measures are learned and followed by the users.
- You can download the most up-to-date user's guide from our website: [ATTACUSfitness.com](https://ATTACUSfitness.com).

## 2 Safety Precautions

**Warning!!** To reduce the risk of burns, fire, electric shock, or personal injury, please observe the following:

- Please follow the instructions from the manual.
- **DO NOT** use additional components, attachments, or accessories that have not been recommended by the manufacturer.
- Please check the components on a regular basis. Keep the components tightly installed. Please do not use the equipment when there is any malfunction, damage, or missing parts and contact your distributor for maintenance or for spare parts for the damaged/missing component. **DO NOT** use the equipment before it is well-maintained.
- ATTACUS is not responsible for any personal injury or death caused by faulty assembly, self-modification/disassembly, or any other ways the user fails to follow the manual.
- It is highly recommended for you to consult your doctor and run a full health check to find a proper and appropriate exercise program if you are any of the following: pregnant, having chronic health condition like hypertension and cardiovascular diseases, smoking, over 45 years old, obese, or not having proper exercise routines for more than one year.
- This equipment is not suitable for anyone who is poor in physical, sensory, or mental capacity. Children under 13 years old are not allowed to use the equipment. **DO NOT** let children or pets near within 10 inches (3 meters).
- The persons with reduced physical, sensory or mental capabilities, or lack of knowledge, and the adolescent from 13 to 19 years, or the aged over 65 should not be on the equipment without proper and constant supervision by a potter/supervisor.
- **DO NOT** attempt improper use of the product, such as jump onto the treadmill, or standing, or sitting on the motor cover, or roller end caps of running deck.
- Please place the treadmill in an indoor environment with a flat and stable floor. It is highly recommended to put the treadmill on a shock and sound-absorbing treadmill mat to protect the floor and enhance the quality of use.
- This equipment is for indoor use only. Please avoid keeping the equipment in places with extreme temperature and humidity, or is dusty or susceptible to the splash of water and fluid.
- **DO NOT** operate the treadmill where aerosol (spray) products are being used or when oxygen is being administered.
- Please operate the treadmill with clearance of 79 in (2 m) on the backside and 2 ft (0.6 m) on both sides.
- Under any circumstances, the equipment is for one person to use only. **DO NOT** have more than one user using it simultaneously.
- Maximum user weight limit: 220 lb (100 kg).
- Please connect this treadmill to a properly grounded outlet only. Any alteration or

misuse will nullify warranty rights.

- Please be sure to wear proper exercise attire and athletic shoes. Wearing a loose blouse or having your shoelaces loosen may cause injury or death when the loose parts being grind into the machine.
- Please be sure the safety key is clipped on your clothes before using the treadmill.
- When exercising, always maintain a comfortable pace.
- Improper training and/or overtraining can cause serious physical injury or death. If you are experiencing any kinds of pain, nausea, dizziness, shortness of breath, etc., Stop exercising immediately and consult a doctor.
- Please disconnect the safety key to prevent uncontrolled usage of third parties.
- When folding the treadmill, please be sure the treadmill's running deck is at its lowest inclination level and is power off. **DO NOT** operate the treadmill when it is folded.
- Please use a damp cloth to wipe down the treadmill. **DO NOT** use solvent-based cleaners.
- **DO NOT** drop or insert any object into any opening. As obtrusive object in opening may cause electrical shock.
- **DO NOT** operate under blanket or any fabric. Excessive heating can occur and cause fire, electric shock, or injury to persons.
- Make sure the belt is at the center of the deck and not leaning to either side of footrest rails. If the belt is not centered, please calibrate.
- Please do not remove the outer cover without the instruction of your local distributor or certified professionals. Service should only be done by an authorized technician.

### **Warning!**

- Please be sure to read through and be familiar with the instructions and warnings from this guide. This will reduce the potential for injury and insure your safety.
- Please consult your physician before starting any exercise plan. Improper training or overtraining can result in serious injury or death.
- To prevent electrical shock, always turn off and unplug the machine before cleaning, performing maintenance and removing parts.

# 3 Assembly

Please thoroughly read through the manual before assembling. If you have any questions, please consult your distributor or see more information on our website: [ATTACUSfitness.com](http://ATTACUSfitness.com). Please have your model number and serial number ready when you call.



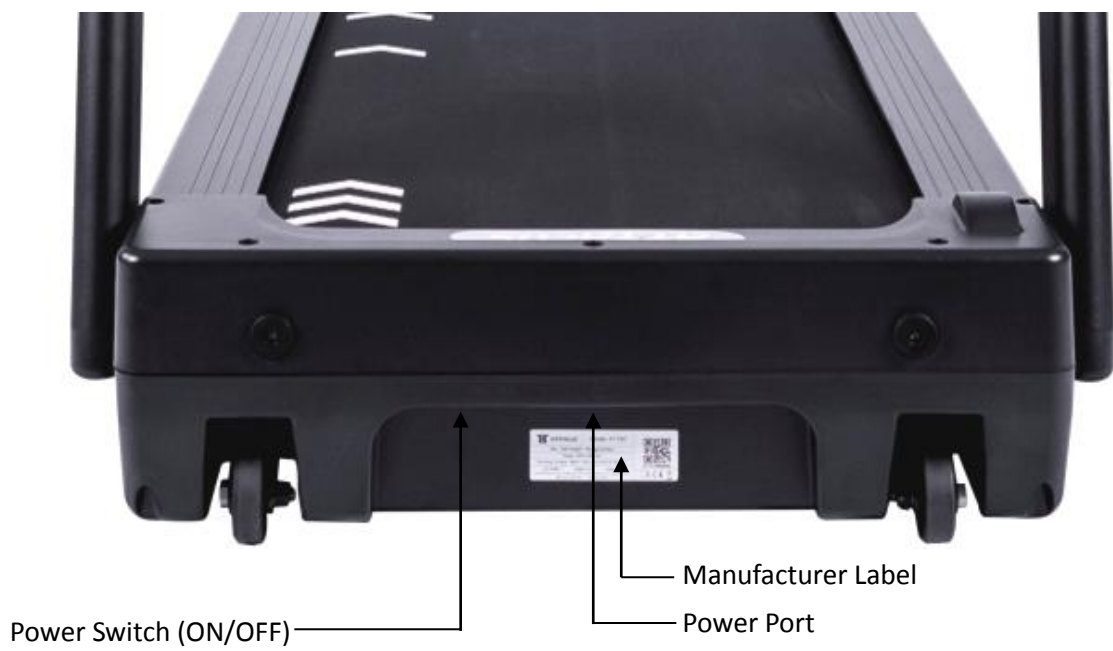



## Serial Number and Labels

Please be sure to have your model name and serial number ready before calling the customer service. The model name and serial number can be found on the manufacturer label, or by scanning the QR Code sticker on the right of the tablet rack.

Model: AT100

SN:

--	--	--	--	--	--	--	--	--	--	--	--	--	--	--	--

Scan the QR Code to get the following:







- Connect and pair with the APPs.
- Register the product.
- Download the most up-to-date operation guide.

**⚠ WARNING !**  
Keep body parts away from this area. High current may cause injury.

**⚠ CAUTION !**  
To avoid any personnel injury, DO NOT step on or remove this plastic structure or any related parts.



### 3.1 Parts List

	Image	#	Specification
Components		1	Safety Key
		2	Handrail
		1	Power Cord
		4	Hexagon Socket Head Cap Screw (M6x16L)
Included Tools		1	6mm Hexagon Key
		1	5mm Hexagon Key
		1	30ml Treadmill Silicone Lubricant

### 3.2 Placement of the Equipment

Please place the equipment on a level ground and avoid direct sunlight. **DO NOT** place it outdoors, in the garage, open yard, humid, and/or ventilated places.

Please consider both the user's height and the maximum inclination rate to ensure the treadmill is placed in a proper space. To ensure operation safety and avoid any blockage in usage, please keep clear at least 2 ft (0.6m) on both sides of the treadmill, 79 inches (2m) on the rear end, and 1 ft (0.3m) at the front.

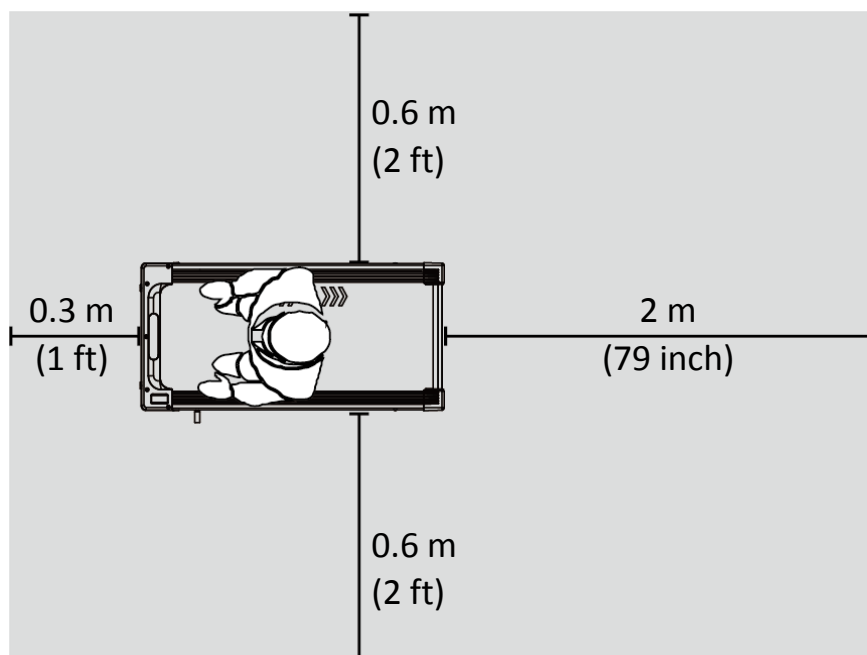

## Attention

- Keep children and pets away during assembly.
- If you have any questions or the equipment has any missing parts, please contact your distributor or dial in the customer service number on the maintenance card.
- The treadmill is heavy; use care and additional help if necessary when moving. Do not attempt to move or assemble alone with single hand.
- When the product arrives, please carry it carefully. Place the carton box on a flat surface. Do not open the box when it is placed on its side to prevent parts from falling out.
- Please unpack and assemble the product on a set location to reduce unnecessary moving.
- Please be careful when removing the cable ties on the package exterior. The cable ties outside the box may produce strong momentum; it might bounce off and snap on the people around if not cautiously removed.
- When unpacked, please place all the components in a clear area to enhance the assembling process.
- The treadmill should be assembled and operated on a flat surface. It is highly recommended for you to place a treadmill mat underneath to protect your flooring.
- Please follow the proper instructions. When performing each step, please be sure all the screws and bolts are in place and partially tighten. Please tighten all the screws and bolts once all are in place.
- Please be sure all the loose components are fixed and tightened. Please do not reduce the number of screws and/or bolts used to prevent unwanted danger and harm.
- Some parts are pre-lubricated to help with the assembly. Do not wipe off the grease.
- Unauthorized personnel are prohibited to remove the maintenance covers.
- Before the assembly is completed, do not throw away the packaging material.

### 3.3 Assemble Steps

#### STEP 1

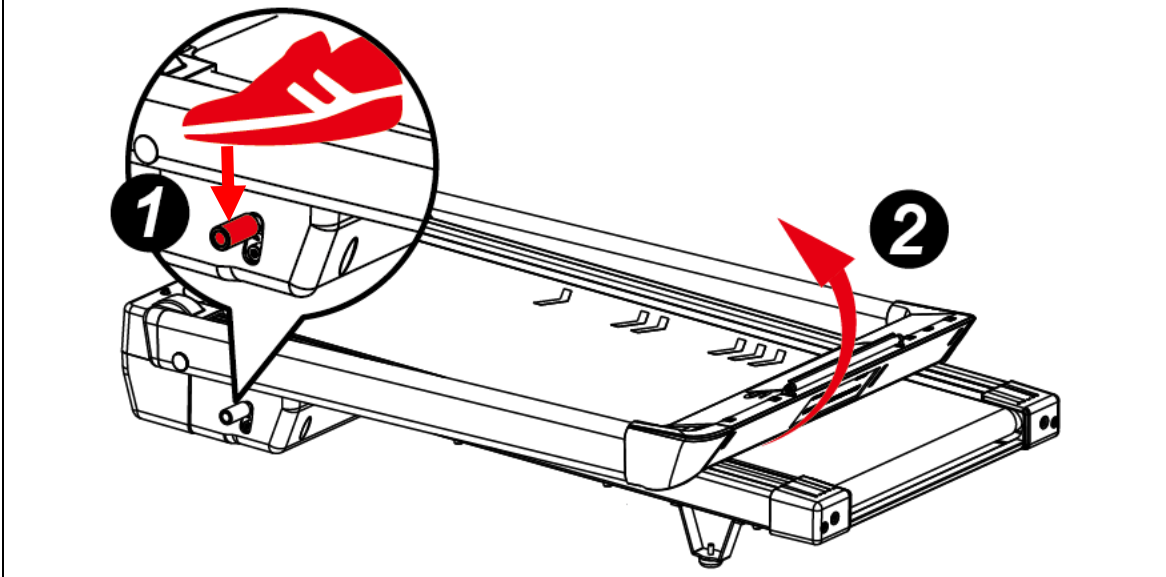

#### Expand the Treadmill

- 1) Step on the folding lever and push up the console into position.
- 2) Carefully lift the console mast into the upright position until lock latch engages with a "click."
- 3) Make sure the console mast is securely latched before letting go.

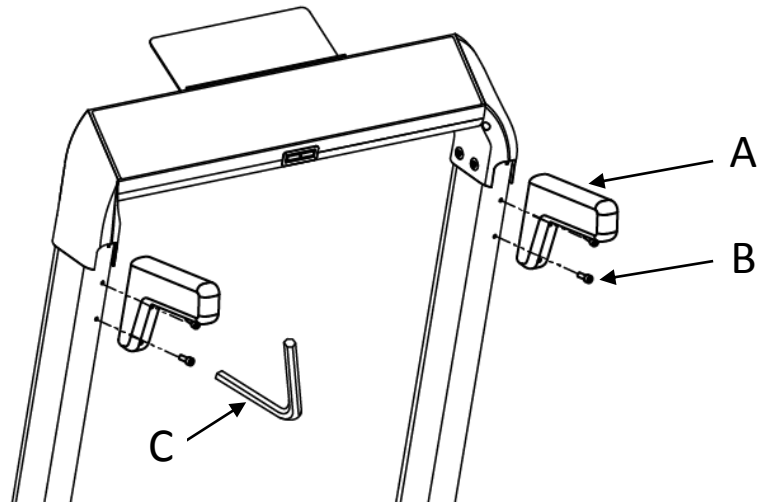

## STEP 2 Assemble the Handrails



Parts in letters	Parts Images	Specification	# of part used
A		Handrail	2
B		Hexagon Socket Head Cap Screw (M6×16L)	4
C		5mm Hex Key	1

## STEP 3

### Expand, or Fold Down the Tablet Rack

- 1) Expand: See *Figure A*, lift up the tablet rack.
- 2) Fold down: Push the tablet rack slightly to the left and fold it backward. (*Figure B*)

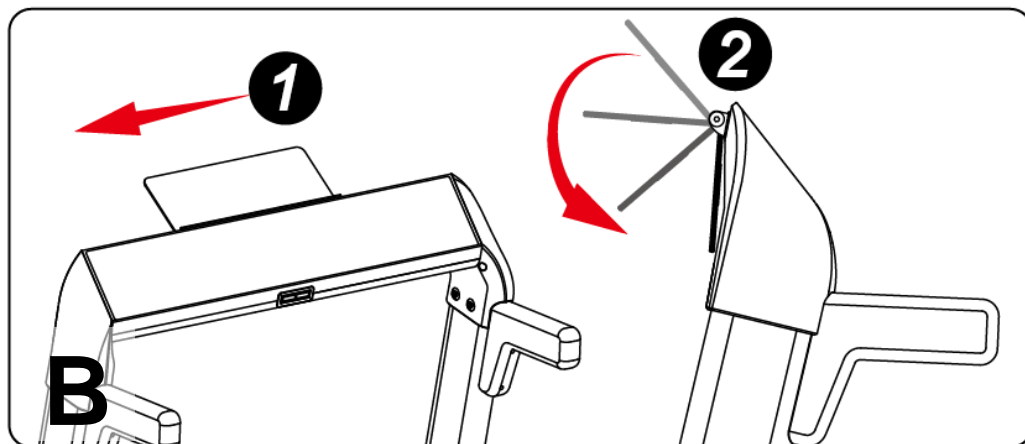
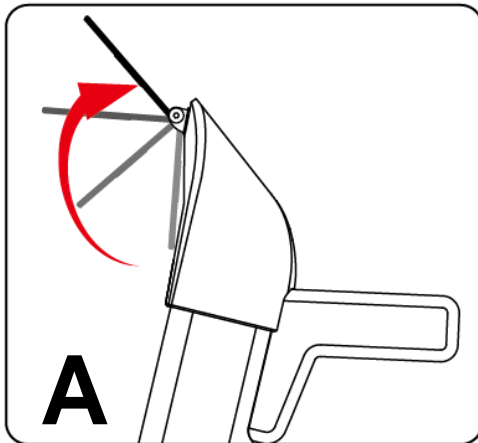

## STEP 4

## Install the Safety Key

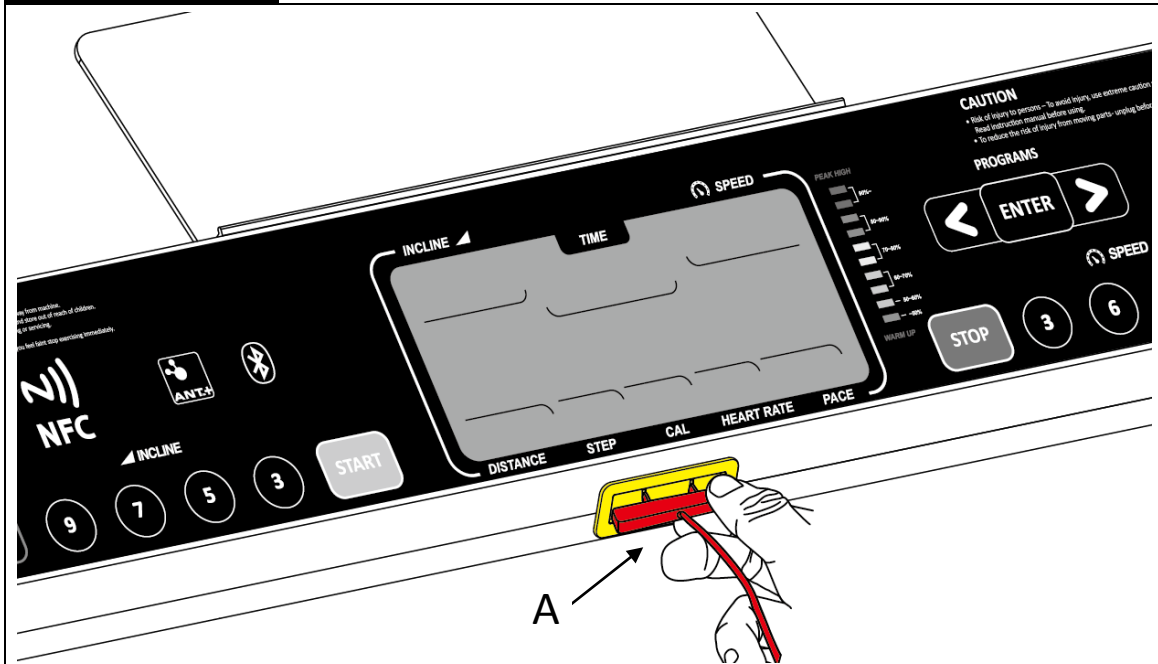

Parts in letters	Parts Images	Specification	# of part used
A		Safety Key	1

### Attention!

- The treadmill will not start unless the safety key is installed in position.
- Attach the clip end securely to your clothing. This safety key is designed to cut off the power of the treadmill in the case of emergency.
- **DO NOT** remove the safety key other than in the case of emergency. The treadmill will come to a sudden halt that may cause injury on the user due to the loss of balance.
- Please check if the safety key is functioning properly on a biweekly basis.
- When the treadmill is not in use, please remove the safety key prevent accidental operation caused by children or unaware personnel.

## STEP 5

### Power Cord

The treadmill cord has a grounding plug. The plug must be plugged into an appropriate outlet that is properly installed and grounded in accordance with local regulations.

- 1) Plug the cord on the port on the front end of the treadmill.
- 2) Plug the plug properly to a 3-pole Grounded outlet.

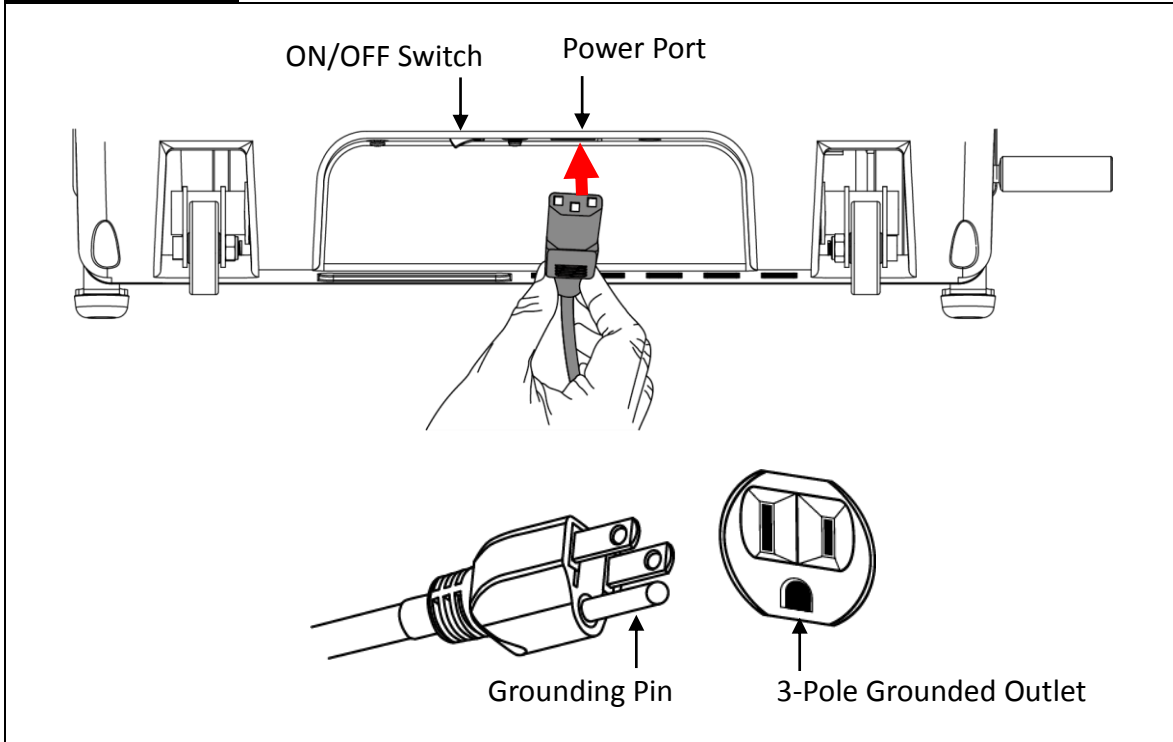

### ⚠ Attention!

- This equipment must be grounded. If a treadmill should malfunction or breakdown, the grounding provides a path to release excessive electrical current to reduce the risk of electrical shock.
- Improper connection of the equipment-grounding conductor can result in a risk of electric shock. Check with a qualified electrician or service provider if you are in doubt as to whether the product is properly grounded.
- **DO NOT** modify the plug provided with this product. If it will not fit the outlet, have a proper outlet installed by a qualified electrician.
- The treadmill must be used on a dedicated outlet. No adapter or extension should be used with this equipment. See the voltage label below the power switch. Improper connection of the equipment-grounding conductor can result in a risk of electric shock.
- Unplug from outlet when not in use, before cleaning, and performing maintenance.
- Never operate the treadmill if it has a damaged cord or plug, or is not working properly. Please contact customer service or your distributor for replacement or repair.



**ASSEMBLY COMPLETE!**

Before the first use, lubricate the running belt and deck by following the instructions in [8 Lubrication](#).

### 3.4 Folding and Moving Guideline

Please fold the treadmill first and securely latched before moving it and be sure to use both hands when lifting it. Follow the instructions below to ensure your safety:

- 1) Fold the tablet rack: Push the tablet rack slightly leftward and fold it back.
- 2) To fold the console masts, step on the folding lever, and with one hand on a mast and one on a handle, slowly fold the mast downward toward the belt.

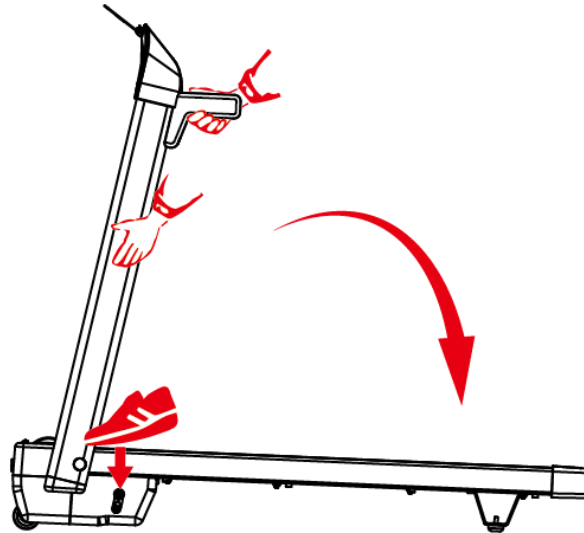

- 3) Crouch down to the ground to lower the center of the body. Grasp on both rear ends and lift the machine up with both hands.

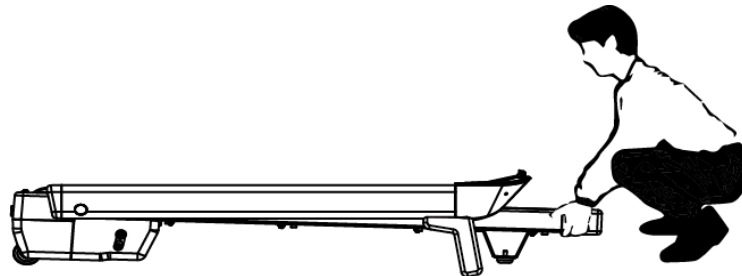

- 4) Lift it up until the transportation wheels are maneuverable.

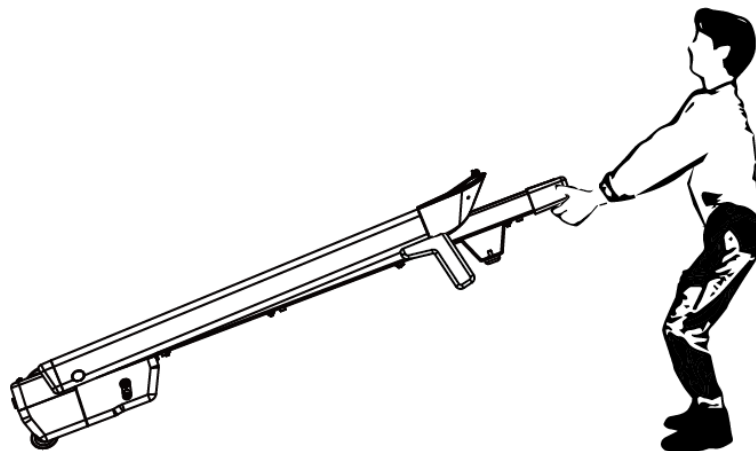

- 5) Once the treadmill is in-position, place it gently to the floor.

6) If to store the treadmill horizontally, lift the rear end until the fixed foot pads on the motor cover are securely on the ground.

👉 Please make sure to have a fitting space enough for treadmill to be straightened and close to the wall.

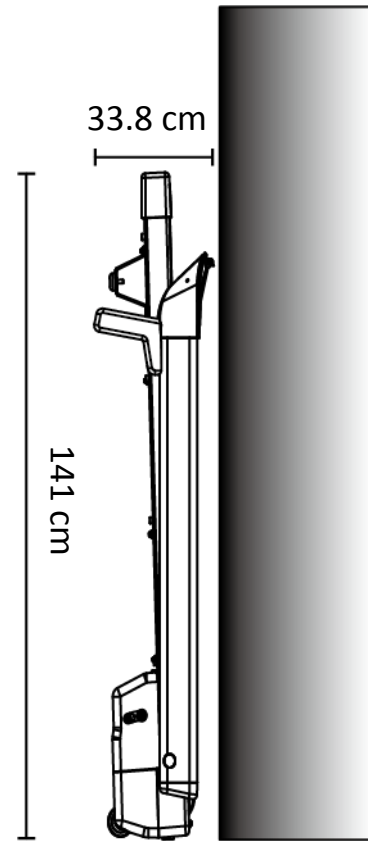

### **Attention!**

- Please make sure the treadmill is at its lower inclination level, is power off and unplugged before folding and moving.
- **DO NOT** move the treadmill when it is not properly folded.
- The treadmill is heavy; use care and additional help if necessary when moving.
- Be aware of your gripping position on treadmill when moving to prevent being caught in the machine.

## 4 Preparation

Running is a simple and efficient cardio exercise. Treadmill is an essential tool for you to establish or maintain a habit of running. Exercising on a regular basis could benefit both physical and mental health by enhance metabolism, cardiovascular capability, and engage in weight loss.

■ **Before starting your training plan, be sure to consult your doctor or a professional trainer.**

■ **To prevent possible injury, please evaluate your physical condition and be sure to do the following:**

- 1) Please warm up properly before the workout.
- 2) Check to make sure no objects are placed on the treadmill belt.
- 3) Check to make sure the safety key is correctly installed and the clipping end is clipped onto your clothes.
- 4) Please **DO NOT** stand on the belt when you start the treadmill. Please stand on the side foot rests and have you hands properly placed on the handle before you started. Please start slow, then speed up accordingly when you are used to the speed.
- 5) Please stay focused during workout and maintain the correct posture. If you are using a tablet or other devices please ensure your own safety and be mindful of your posture to avoid any danger or injury.
- 6) Please adjust your training time and intensity according to your own physical condition. Overtraining will cause chronic fatigue and/ or severe physical injury.
- 7) Please slowdown and walk for at least 3 minutes. **DO NOT** leave right after workout or you may experience dizziness or imbalance. Once the body is properly cool down, you may stop the belt and leave the treadmill.
- 8) After workout please properly stretch and massage your muscles to reduce physical fatigue.

■ **Exercise Guidelines for Adults (HPA):**

Benefits	Activities	Freq.	Duration
Improve cardiorespiratory fitness and endurance.	Aerobic exercise such as running, power walking, swimming, cycling, dancing, rope skipping, ball games, traditional fitness, etc.	At least 3 times a week.	At least an average of 20 minutes per time.
Enhance muscular strength and stamina	Weight training, Pull-ups, Push-ups, etc.	At least twice a week.	At least 1~3 sets each time. At least 10~20 reps per set. Take a 2~3 minutes break in between
Improve flexibility.	Stretching exercises, traditional fitness, gymnastic ,etc.	At least 3 times a week.	Stretch at least 8~10 parts of your body. Each muscle stretch at least 20~30 seconds and perform 1~3 repetitions.

Improve body mass (Maintain a healthy percentage of body fat).	Mainly Aerobic exercise supplemented with weight training.	At least 3 times a week.	At least 20 minutes each time. At least 1~3 groups per day.
--	--	--------------------------	--

Reference: <https://www.hpa.gov.tw/Pages/Detail.aspx?nodeid=571&pid=882>

## Attention!

- Always wear proper running shoes while using this equipment. Do not operate the machine barefooted or wearing only socks.
- **DO NOT** wear loose clothing, dangling accessories, or have loose shoe laces. These parts may be caught into the machine.
- If you are experiencing any kind of pain, nausea, dizziness, shortness of breath, etc., Stop exercising immediately and consult a doctor if the symptoms persist.
- In case of emergency which the machine is unstoppable, immediately remove yourself from the treadmill by standing on the side footrests.

# 5 Control Panel & Display Window

## 5.1 Keys

Under Sleep Mode, *press any key* to wake the screen. Please see the function of each key below:

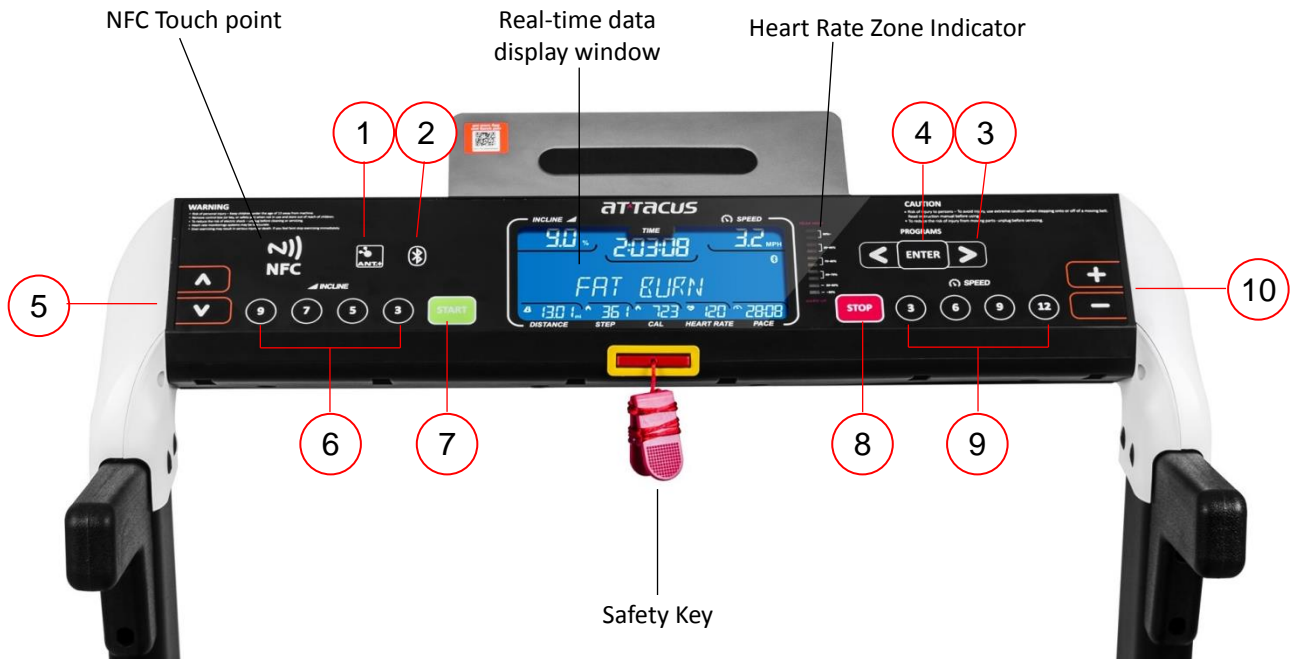

1	Press and hold for 2 sec to connect ANT+ heart rate device.
2	Press and hold for 2 sec to connect Bluetooth heart rate device.
3	Program Selection: Press to select your desired program. Press to adjust time in the Sport Mode.
4	Enter Key: Press to confirm.
5	Inclination adjustment: Press to adjust incline per units. Press to adjust values in the Sport Mode.
6	Inclination Shortcut: Press to reach desired incline. A total of four incline options, 3/5/7/9, the larger number indicate steeper inclination. (Unit: %)
7	Start Key: Press to begin exercising. Press to resume exercising after pause.
8	Pause/Stop Key: Press to pause your workout. Press twice to end your workout.
9	Speed Shortcut: Press to reach desired speed. A total of four speed options, 3/6/9/12, the larger number indicate the faster speed. (Unit: km/h)
10	Speed Adjustment: Press to adjust speed by units. Press to adjust values in the Sport Mode.

## 5.2 Data Fields



Standby Window

Figure/ Icon	Data Fields
<b>%</b>	<b>Incline:</b> Indicates the current inclination level. Inclination is shown through percentage. The range is 3.0% ~ 9.0%. Under the sport mode, it is shown as <i>P01</i> to <i>P17</i> .
<b>0:00</b> <b>0:00:00</b>	<b>Time:</b> Shows either the exercise time remains or the time elapses. Within the first hour, the time is displayed as <b>MM:SS</b> . When the time exceeds 59 minutes 59 seconds, the display is <b>H:MM:SS</b> . The total display limit is 9 hours 59 minutes 59 seconds.
<b>KPH</b>	<b>Speed:</b> Shows the current running or walking speed, it is displayed as km/h. The range is 1.0-16.0 km/h.
<b>A</b>	<b>Distance:</b> Displays the completed or the remaining distance. The unit in display is Kilometer (km). The display limit is 99.99km.
<b>Foot</b>	<b>Steps:</b> Step count of the current workout. The display limit is 9999 steps.
<b>Flame</b>	<b>Calories:</b> Display the total calories burned. The display limit is 9999 cal.
<b>Heart</b>	<b>Heart Rate:</b> Displays your heart rate <sup>1</sup> . The unit in display is beat per minute (BPM).
<b>Wheel</b>	<b>Pace:</b> Displays as <b>MM:SS</b> to indicate the amount of time required to finish each one kilometer under the current speed.
<b>ANT+</b>	<b>ANT+:</b> Status of ANT+ connectivity with heart rate device (HRM). Once the ANT+ HRM is connected the ANT+ icon will stop flashing and remain statically on.
<b>Bluetooth</b>	<b>Bluetooth:</b> Status of Bluetooth connectivity with heart rate device (HRM). Once the Bluetooth HRM is connected the Bluetooth icon will stop flashing and remain statically on.

Message	Description
WELCOME	Indicates <b>Standby Mode</b> <sup>2</sup> .
LUBE	<b>Running Belt Lubrication Notification</b> <sup>3</sup> . Press <b>STOP</b> key to exit LUBE Notification and go to standby window.
PLUG IN SAFETY	Indicates that the <b>Safety Key</b> is not intact <sup>4</sup> .
E00	Indicates <b>Error Code</b> . Please record the number shown and unplug the machine. Please show the error code to your distributor for customer service, be sure to record both digits of the error code as "E##"

### Attention!

- **DO NOT** remove the Safety Key other than in the case of emergency. The treadmill will come to a sudden halt that may cause injury on the user due to the loss of balance.
- When the Safety Key is removed, the ongoing program will be terminated immediately and data deleted. The treadmill could not be operated until the Safety Key is installed appropriately back to the port.

### Footnote

- 1 Heart rate reading will only appear when the console is connected to an external heart rate device.
- 2 The default standby mode is 20 minutes, if there is no operation from the keys, the screen will enter Sleep Mode after 20 minutes. Under Sleep Mode, you can *press any key* to wake up the screen.
- 3 The lubrication notification will appear on the screen upon turning on to inform the users that the belt is in need of lubrication. Please see more in [8. Lubrication](#).
- 4 When the Safety Key is removed, the notification "Plug in safety" will continuously appear on the screen until the safety key is properly installed back to the port. Once it is installed, the standby "Welcome" screen would resume and the operation keys would be available to use.



## 5.3 Pairing with NFC

NFC<sup>1</sup> is a technology that builds quick and short-distance wireless connection between Bluetooth devices. If you have an NFC heart rate monitor, all you need to do is place the device close to the console. It will automatically transfer the heart rate data over.

Below is a demonstration of NFC pairing with the **ATTACUS** Obeat 3 Armband:

1. Turn on your sensor<sup>2</sup> and wear the sensor on the inner forearm or upper arm.
2. On the Console: *Press any key* to wake the display screen.
3. Bring the front side of your sensor close to the **NFC** touch point on the console as shown in *Figure A*.
4. Once connected, the  icon on the right side of the screen will be on. *See Figure B*.
5. Check if the heart rate is properly displayed on the lower right side of the screen. *See Figure C*.
6. On the Console: *Press START*<sup>3</sup> to begin exercising. *See Figure D*.

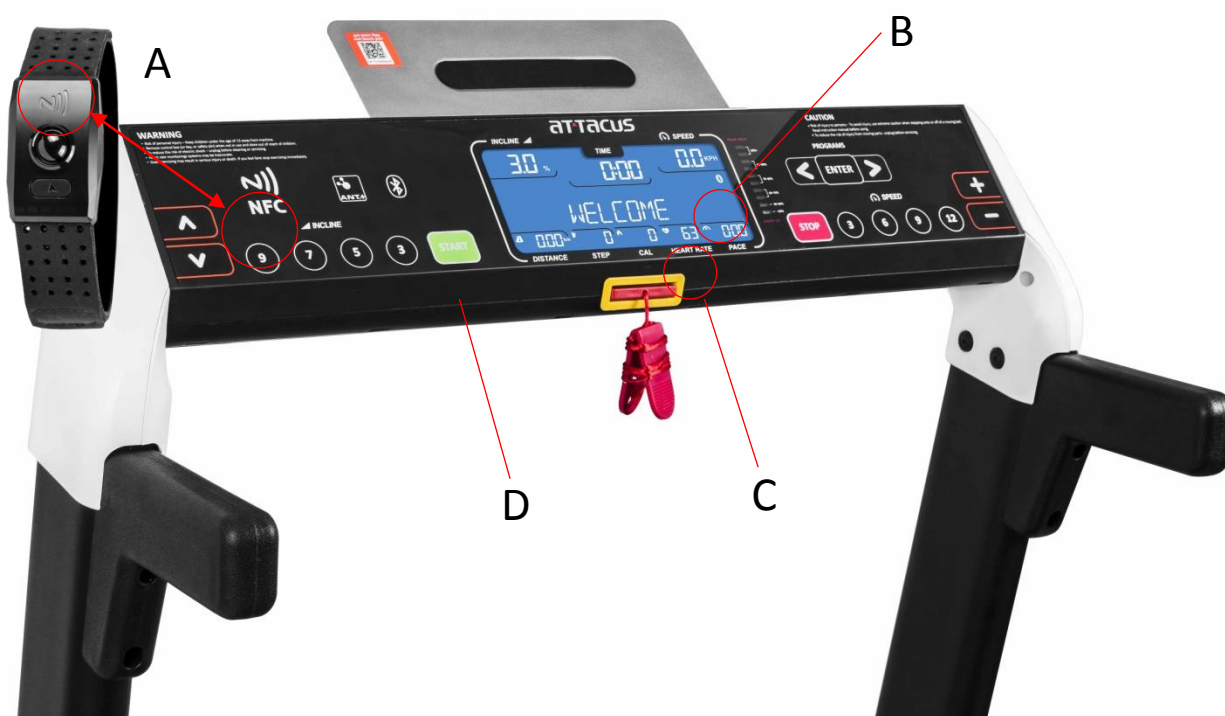

### Footnote

- 1 NFC Tag (Passive).
- 2 If you are interested to learn more about **ATTACUS** Obeat 3 Hear Rate Armband, please see the [User Quick Guide](#).
- 3 Once you start working out, the NFC detection will be closed after one minute; it is recommended that you pair the device first before you *pressing START* key.

## 5.4 Heart Rate Zone Indicator

The heart rate light will shift according to different heart rate zones. The higher workout intensity, the closer for the heart rate zone to reach the PEAK HIGH (Red), whereas the lower the intensity, it gets closer to the WARM UP (Blue). The Heart Rate Zone is a helpful indicator for one to understand the physical condition and adjust intensity accordingly.

Light	Heart Rate Zone		Training Intensity%			Feel	Training Functions	Purpose
			%MHR	THR of 30 years old	Yours THR			
Red	Z5	Maximum Effort	90~	171~ bpm	bpm	Out of breath & short heartbeat	Explosive power	Explosive power
Orange	Z4	Anaerobic	80~90	152~171 bpm	bpm	Feeling strenuous, can't talk comfortably	Increase speed & lactate threshold	Get faster & stronger
Yellow	Z3	Aerobic	70~80	133~152 bpm	bpm	Tired & hard to keep talking	Enhance aerobic power	Aerobic fitness
Green	Z2	Fat Burn	60~70	114~133 bpm	bpm	Talking while exercising	Improve metabolism	Lose excessive weight
Cyan	Z1	Warm Up	50~60	95~114 bpm	bpm	Fully relax	Facilitate warm-up & energy recovery	Get fit
Blue	<Z1	Daily Life	~50	~95 bpm	bpm			

### Warning!

- Heart rate monitors may be inaccurate for certain individuals or under some circumstances. The heart rate may display as higher or lower than the actual heart rate for individuals of certain physical features or under certain special activity.
- The heart rate device is for your reference only; it is not a medical device. Overtraining may cause serious injury or death. If you are experiencing any discomfort, please stop exercising immediately.

### Tips

- To enable this function, you need a Bluetooth or ANT+ Heart Rate Device to connect to the console.
- Heart Rate Zone is one of the most common workout indicators to quantify workout intensity. It is usually based on Maximum Heart Rate %MHR, which defines the 5 zones. Firstly, one would measure the maximum heart rate ( $MHR=220-Age$ ) and times it with the intended intensity percentile.  
For instance, for a 30 year-old person, the maximum heart rate would be  $220-30=190$  bpm the intensity level of 80% would give:  $190 \times 0.8=152$  bpm.
- Following the previous example, the THR (target heart rate) of a 30-year-old person is 152 bpm.

## 5.5 Sport Mode

You can select from the following sport mode:

- Mode Types

**BASIC:** Insert designated training time and basic user info. Then proceed to train.

**HRC:** Insert designated training time, basic user info, and the target heart rate (THR). Then proceed to work out. The inclination would adjust automatically according to the user's current heart rate. A Bluetooth or ANT+ heart rate device is required to enable this function.

**GOAL:** Insert goal and basic user info. Then proceed to work out.

**CUSTOM:** Insert sports time, basic info, and personalized profile indicators. Then proceed to work out.

- Program List

Mode	No.	Profile Name	Time (minutes)	Description
<b>BASIC</b>	P01	Manual	30	<ul style="list-style-type: none"> <li>● Manual Mode</li> <li>● Time, speed, and inclination are adjustable at any time during the workout.</li> </ul>
	P02	Random	30	<ul style="list-style-type: none"> <li>● This mode will change the inclination randomly to enhance calorie burn rate.</li> <li>● Time, speed, and inclination are adjustable at any time during the workout.</li> </ul>
	P03	Cross Country	30	<ul style="list-style-type: none"> <li>● This mode simulates hiking experience through constant uphill practice. This mode helps with enhancing one's muscle.</li> <li>● Time, speed, and inclination are adjustable at any time during the workout.</li> </ul>
	P04	Weight Loss	28	<ul style="list-style-type: none"> <li>● The best zone for fat burn is 60~70% of your maximum heart rate.</li> <li>● Time, Speed, and Inclination are adjustable at any time during the workout to maintain your heart rate within the set range.</li> </ul>

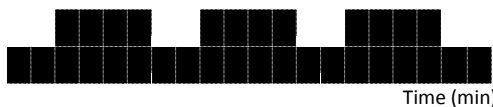
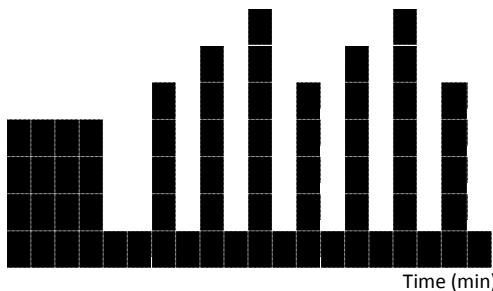
Mode	No.	Profile Name	Time (minutes)	Description
<b>BASIC</b>	P05	Interval 1-1	30	<ul style="list-style-type: none"> <li>This mode is for high interval training. Preset the 30 min total time into 15 intervals. Each set of interval consist a warm up 60 sec + uphill 60 sec. The process will repeat in the duration of 30 min.</li> <li>Time, Speed, and Inclination are adjustable at any time during the workout.</li> </ul>
				
	P06	Interval 2-1	30	<ul style="list-style-type: none"> <li>This mode is for high interval training. Preset the 30 min total time into 10 intervals. Each set of intervals consists of a warm up 60 sec + uphill 120 sec. The process will repeat in the duration of 30 min.</li> <li>Time, Speed, and Inclination are adjustable at any time during the workout.</li> </ul>
				
P07	Hill		30	<ul style="list-style-type: none"> <li>This mode simulates hiking movements. The preset incline program help to enhance endurance.</li> <li>Time, Speed, and Inclination are adjustable at any time during the workout.</li> </ul>
				

Mode	No.	Profile Name	Time (minutes)	Description
<b>HRC</b>	P08	Target Heart Rate Goal	30	<ul style="list-style-type: none"> <li>● You could insert your own THR. Set the THR= <math>(220-\text{age})\times 80\%</math> for the basis of automatic inclination changes.</li> <li>● If the THR is set as <math>152\pm 2</math> bpm, when the heart rate does not reach 150 bpm, the inclination will increase 1% per 30 sec until it reaches the limit. If the heart rate is <math>\geq 154</math> bpm, the inclination will decrease 1% per 15 sec, until it returns to the preliminary point 3%.</li> <li>● Time and Speed are adjustable at any time during the workout in accordance to one's physical condition and to maintain in the Target Heart Rate Zone.</li> </ul>
	P09	Fat Burn	30	<ul style="list-style-type: none"> <li>● You could insert your own THR. Set the THR= <math>(220-\text{age})\times 65\%</math> for the basis of automatic inclination changes.</li> <li>● If the THR is set as <math>124\pm 2</math> bpm, when the heart rate does not reach 122 bpm, the inclination will increase 1% per 30 sec until it reaches the limit. If the heart rate is <math>\geq 126</math> bpm, the inclination will decrease 1% per 15 sec, until it returns to the preliminary point 3%.</li> <li>● Time and Speed are adjustable at any time during the workout in accordance to one's physical condition and to maintain in the Target Heart Rate Zone.</li> </ul>

Mode	No.	Profile Name	Time (minutes)	Description
HRC	P10	Cardio	30	<ul style="list-style-type: none"> <li>You could insert your own THR. Set the THR= <math>(220-\text{age})\times 80\%</math> for the basis of automatic inclination changes.</li> <li>If the THR is set as <math>152\text{ bpm}\pm 5\%</math>, when the heart rate does not reach 144 bpm, the inclination will increase 1% per 30 sec until it reaches the limit. If the heart rate is <math>\geq 160\text{ bpm}</math>, the inclination will decrease 1% per 30 sec, until it returns to the preliminary point 3%.</li> <li>Time and Speed are adjustable at any time during the workout in accordance to one's physical condition and to maintain in the Target Heart Rate Zone.</li> </ul>
	P11	Heart Rate Hill	30	<ul style="list-style-type: none"> <li>You could insert your own THR. Set the THR=<math>(220-\text{age})\times 65\% \rightarrow 75\% \rightarrow 80\%</math> for the basis of automatic inclination changes.</li> <li>Please insert target training time. The length of each point would be the set time/20.</li> <li>When the current HR does not reach <math>\text{THR}\pm 3\text{ bpm}</math>, the inclination will automatically adjust according to the HR in every 15 sec until the heart rate is within the set range.</li> <li>Speed is adjustable at any time during the workout in accordance to one's physical condition and to maintain in the Target Heart Rate Zone.</li> </ul>

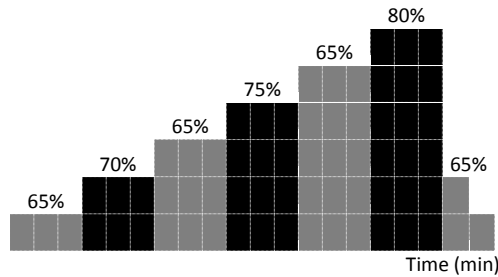



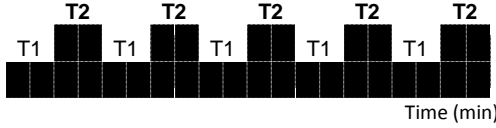
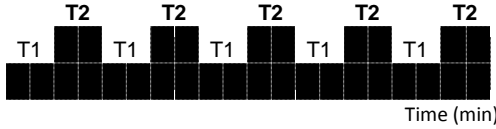

















Mode	No.	Profile Name	Time (minutes)	Description
<b>GOAL</b>	P12	Calorie Goal	On Timer	<ul style="list-style-type: none"> <li>● With a timer on, the program ends once the set Calorie Goal is achieved.</li> <li>● Speed and Inclination is adjustable at any time during the workout</li> </ul>
	P13	Distance Goal	On Timer	<ul style="list-style-type: none"> <li>● With a timer on, the program ends once the set Distance Goal is achieved.</li> <li>● Speed and Inclination is adjustable at any time during the workout</li> </ul>
	P14	Distance Goal 5K	On Timer	<ul style="list-style-type: none"> <li>● With a timer on, the program ends once the set 5K Goal is achieved.</li> <li>● Speed and Inclination is adjustable at any time during the workout</li> </ul>
	P15	Distance Goal 10K	On Timer	<ul style="list-style-type: none"> <li>● With a timer on, the program ends once the set 10K Goal is achieved.</li> <li>● Speed and Inclination is adjustable at any time during the workout</li> </ul>

Mode	No.	Profile Name	Time (minutes)	Description
<b>CUSTOM</b>	P16	Custom 1	Customize	<ul style="list-style-type: none"> <li>This mode is for user to customize training program. Please insert data in the following order: Time → Age → Weight → T1 (Interval uphill, this data is fixed) → T2 (warm up/cool down). Once all set, <b>press START</b> to begin the workout.</li> <li>Time and Speed are adjustable at any time during the workout</li> <li>T1 and T2 are 20 intervals in total.</li> <li>For example, if the time is set for 10 minute, T2=2, it would be <math>T2=(\text{insert time}/20)\times 2</math>. Which means that the repetition would be the following: (T2=90sec, T1=60sec)×4 times.</li> </ul>
				
	P17	Custom 2	Customize	<ul style="list-style-type: none"> <li>This mode is for user to customize training program. Please insert data in the following order: Time → Age → Weight → T1 (Interval uphill) → T2 (warm up/cool down). Once all set, <b>press START</b> to begin the workout.</li> <li>Time, Speed, and Inclination are adjustable at any time during the workout.</li> <li>T1 and T2 are 20 intervals in total.</li> <li>For example, if the time is set for 15 minute, both T1 and T2 are set as 2, then <math>T2=(\text{inserted time}/20)\times 2</math>. The repetition would be the following: (T2=90 sec, T1=90sec)×5 times.</li> </ul>
				







### 5.5.1 Select a Workout or Target



- 1) Under Sleep Mode, *press any key* to wake up the console<sup>1</sup>.
- 2) Use  or  to select Sport Mode and *press ENTER* to confirm.
- 3) Use  or  to select a workout and *press ENTER* to confirm.
- 4) Follow the on-screen instructions to set up<sup>2</sup> and use  or ,  or ,  or  to adjust values, *press ENTER* to confirm. If you want to go back to the previous step, *press STOP*.
- 5) Once setting is completed, *press START* to begin exercising and the console start the elapsed time after the 3 seconds countdown.
- 6) On the screen the message “Warm Up 3 min” appears. Please begin warm up then start to speed up afterwards.
- 7) During the workout out, the following setting remains adjustable:
  - **Adjust preset sections:** *Press ENTER* to switch programs, use the following keys  or ,  or ,  or  to make adjustment. *Press ENTER* once confirmed.
  - **Adjusting inclination:** Use  or  to adjust, or the Shortcut Keys (which four levels are available 3/5/7/9. The larger number indicates steeper inclination).
  - **Adjusting the speed:** Use  or  to adjust, or *press* the Shortcut Keys (There are four levels available 3/6/9/12. The larger number indicates the faster the speed would be).
- 8) **Pause Time**<sup>3</sup>: *Press STOP* once to pause. To resume, *press START*.
- 9) **Stop Exercise:** *Press STOP* twice to enter a 3 minutes Cool Down. If you would like to skip the Cool Down, *press STOP* again. A summary<sup>4</sup> page will appear once the activity has been ended.

## 5.5.2 Quick Start

- 1) Under Sleep Mode, *press any key* to wake up the console<sup>1</sup>.
- 2) *Press **START*** to start the treadmill.
- 3) If you would like to skip the 3 minutes warm up, *press **START*** when seeing the “Warm Up” message and begin exercise.
- 4) During the workout out, the following settings are adjustable:
  - **Adjusting inclination:** Use  or  to adjust, or the Shortcut Keys (which four levels are available 3/5/7/9. The larger number indicates the steeper the inclination would be).
  - **Adjusting the speed:** Use  or  to adjust, or *press* the Shortcut Keys (There are four levels available 3/6/9/12. The larger number indicates the faster the speed would be).
- 5) **Pause Time**<sup>3</sup>: *Press **STOP*** once to pause. To resume, *press **START***.
- 6) **Stop Exercise:** *Press **STOP*** twice to enter a 3 minutes Cool Down.
- 7) If you would like to skip the Cool Down, *press **STOP*** again. A summary<sup>4</sup> page will appear once the activity has been ended.

### **Attention!**

- The console will not store data. It is highly recommended that you train with **Ala Fitness** (see [5.6 Application and Compatibility](#)), or pair the console with **ATTACUS** Optical Heart Rate devices to collect and analyze your workout data.
- Be sure to check if your data has been stored in your compatible devices right after an activity.

### **Footnote**

- 1 When turned on, the console would remain in standby mode with the message “WELCOME” on the screen. If you have a heart rate device, please pair it during the standby mode and make sure the heart rate data has appeared on the screen before *pressing* the **START** key.
- 2 In Settings, the console will return to the standby screen after 30 sec of inactivity.
- 3 The default period of pausing is 2 minutes. If the **START** key is not pressed to resume exercising, the console will automatically stop the timer and show a summary after the 2 minute countdown.
- 4 The “Workout Summary” page will only appear on the screen for 10 sec. *Press* the **STOP** key to exit.

## 5.6 Application and Compatibility

### 1) Pair, Connect, and Start Your Activity.

1-1) Scan the QR code to install **Ala Fitness**.

**System Requirement:**

- iOS 11.0 or later
- Android 5.0 or later
- Built-in Bluetooth 4.0 or later

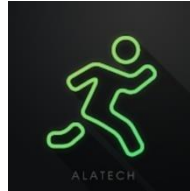

1-2) Please turn on **Bluetooth** on your mobile device.

1-3) Open **Ala Fitness**.

1-4) Follow the on-screen instructions to register on **Ala Fitness** and set up User's Profile.

 Please be sure to key in accurate personal information. The system would need the accurate data to provide personalized analysis and training data. By default, your provided data is not accessible to the public.

1-5) **Ala Fitness:** *Swipe left and select* [Treadmill].

1-6) If you have heart rate devices, *select* [Heart Rate Sensor].

1-7) *Find and select* the serial number or ID number of your device to connect to **Ala Fitness**.

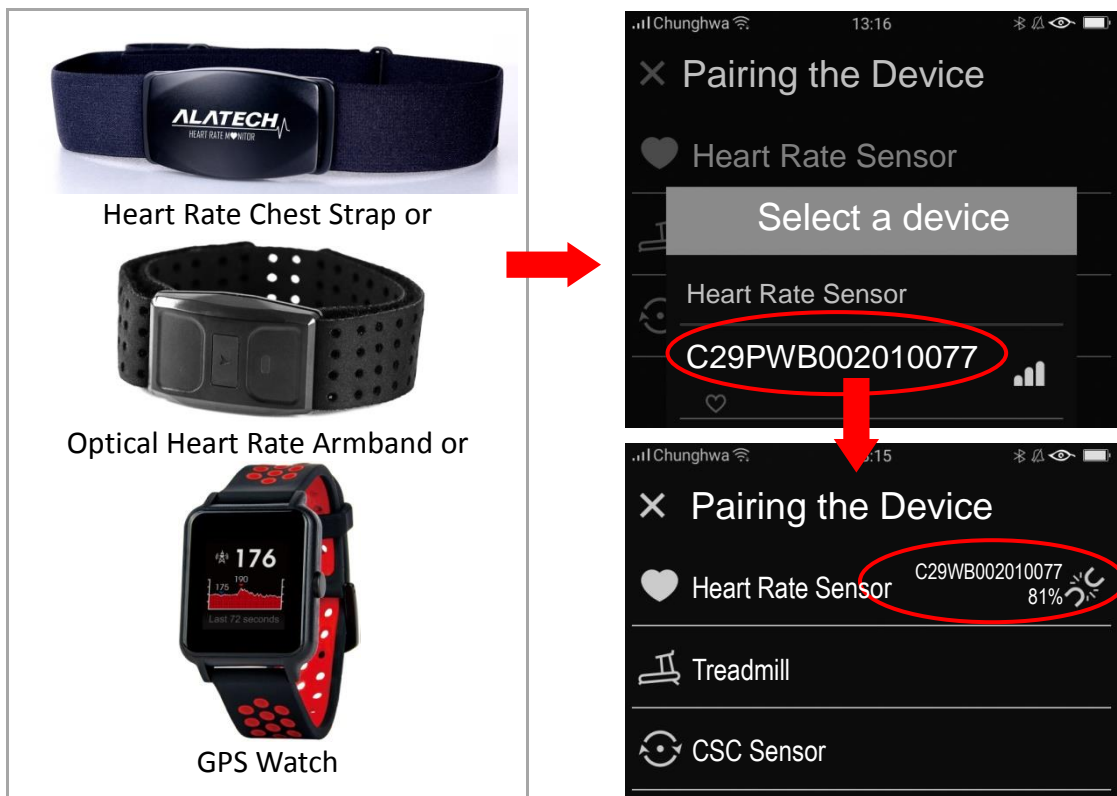

Heart Rate Chest Strap or

Optical Heart Rate Armband or

GPS Watch

Pairing the Device

Heart Rate Sensor

Select a device

Heart Rate Sensor

C29PWB002010077

Pairing the Device

Heart Rate Sensor C29WB002010077 81%

Treadmill

CSC Sensor

 **Ala Fitness** is compatible with Bluetooth heart rate devices. See [9 Specification](#) to select compatible accessories.

Once you have connected your heart rate monitor, follow the instruction below to connect your treadmill with **Ala Fitness**.

1-8) On the Console: *Press any key* to wake the console.

1-9) On **Ala Fitness**: *Select [Treadmill]*.

1-10) From the Search Bar on your mobile device, *select* the serial number printed on the QR Code sticker on your treadmill.



You can find the serial number on the right of the tablet rack.

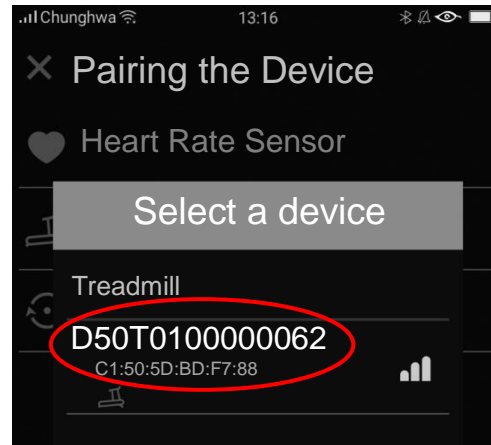

*Select* the serial number printed on the QR Code sticker.

1-11) Once the pairing is successful, it will show on both the console and **Ala Fitness**.

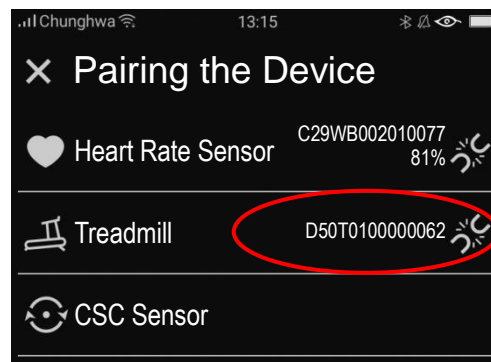

## 2) Start an Activity:





2-1) On **Ala Fitness**: *select [Next Step] > [Start]* then you can begin working out after the 3 seconds countdown.

2-2) On the Console: *Press START* and begin exercise after a 3-seconds countdown.

## 3) During an Activity:

3-1) *Swipe left or right* on **Ala Fitness** to view real-time data.

3-2) During the workout out, the following settings are adjustable:



- Adjusting inclination: Use  or  to adjust, or the Shortcut Keys (which four levels are available 3/5/7/9. The larger number indicates the steeper the inclination would be).
- Adjusting the speed: Use  or  to adjust, or *press* the Shortcut Keys (There are four levels available 3/6/9/12. The larger number indicates the faster the speed would be).

#### 4) End an Activity:

4-1) On **Ala Fitness**: Select [Unlock]> [Pause] > [Stop] to end the activity.

4-2) On the Console: Press **STOP** twice to stop. On the 「 **Workout Summary** 」 display, press the **STOP** key to return to standby mode.

4-3) *Swipe left or right* on **Ala Fitness** to view workout summary.

4-4) If you would like to save this record, select . If you would like to discard, select .

 Data saved by the app will be stored on cloud but not the console. To view your workout report and data, sign in to [gptfit.com](https://gptfit.com).

# 6 Maintenance

To ensure the safety of the user and prolong the equipment's lifespan, the treadmill needs to be inspected and maintained on a regular basis.

Please read and follow the instructions below. If you have any questions regarding the maintenance of the equipment, please contact customer service or your distributor.

Frequency	Action
Before use	<ul style="list-style-type: none"><li>● Clean the belt after use and keep running shoes clean.</li><li>● Check if the parts are intact and not loose, worn, or broken (especially the deck, belt, and footrest).</li><li>● Please check if the belt is off-center or loosed (<a href="#">See 7 Belt Adjustment</a>)</li></ul>
After use	<ul style="list-style-type: none"><li>● Please use a wet cloth to wipe down the sweat on the belt, side footrests, motor cover, and console, and keep the machine dry.</li></ul>
Weekly	<ul style="list-style-type: none"><li>● Please check if the roller(s) is running smoothly.</li><li>● Please clean the dust and trash underneath the treadmill. Wipe down the entire machine with a damp soft cloth. Keep the treadmill dry afterward.</li></ul>
Biweekly	<ul style="list-style-type: none"><li>● Check if the Safety key is working properly</li></ul>
Monthly	<ul style="list-style-type: none"><li>● Check if all the screws and bolts are properly intact, tighten these parts if necessary.</li><li>● Straighten the treadmill to inspect if any part is loose or fallen apart.</li></ul>
Every 100 kilometers	<ul style="list-style-type: none"><li>● Lubricate with treadmill silicone oil. (<a href="#">See 8 Lubrication</a>)</li></ul>
Yearly	<ul style="list-style-type: none"><li>● Please apply lubricant on all the metal bearings with a soft cloth.</li></ul>

## Attention!

- Before cleaning or performing maintenance, please be sure the treadmill is off and unplugged.
- To avoid damaging the belt, please apply treadmill silicone oil; **DO NOT** apply petroleum-based degreaser.
- **DO NOT** operate the machine if any part is found broken, worn, or malfunctioned. Please contact your local distributor for maintenance services before resume to use.

# 7 Belt Adjustment

## 7.1 Center the Belt

Different running postures and habits could cause the belt to shift to the sides. If the belt is off-centered, please calibrate it accordingly.

1. Tools: 6mm Hex Key.
2. Press the **START** button to start the treadmill, keeping the speed between 8~10 km/h.
3. Observe the off-centered belt.
4. If the belt is leaning toward the right:
  - 4-1) Insert the Hex Key into the right adjusting bolt, adjusting by turning a quarter clockwise.
  - 4-2) Observe for a minute to see if the belt has centered. If not, please continue to adjust until it does.

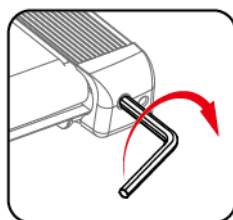

5. If the belt is leaning toward the left:
  - 5-1) Insert the Hex Key into the left adjusting bolt, adjusting by turning a quarter clockwise.
  - 5-2) Observe for a minute to see if the belt has centered. If not, please continue to adjust until it does.

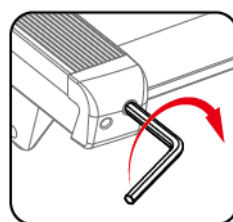

6. Once the calibration is completed, press the **STOP** button three times to stop the belt.

**⚠** During the calibration process, **DO NOT** touch the moving belt. Keep children away from the moving belt. Beware of clothing and hair not to be caught in the machine.

## 7.2 Adjusting Belt Tension

The running belt will naturally go loose after use, if slipping begins to occur, it means the belt is too loose.

Please also note that by applying too much tension will cause excessive friction between the belt and roller, and consequently reduce the product performance and lifespan.

When you find that your belt has been too loose or tight, please adjust according to the following.

1. Tools: Needed a 6mm Hex Key and a ruler.
2. Turn off the power.
3. Insert the Hex Keys on both the right and left adjustment bolts. Turn simultaneously a 1/4 circle on each side and lift up the belt to measure the said distance between the belt and the deck.

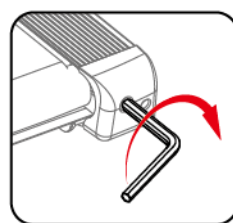
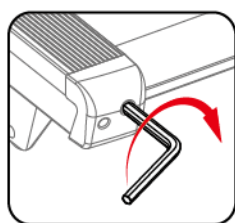

4. Repeat step 3 until the distance is about thumb-wide or an inch (approx. 24.5mm).



5. To ensure the belt is in its proper tension, turn the treadmill on and began operation. Set the speed between 6~8 km/h. On steady steps, insert a couple of heavy stumps in between the steps. If the belt did not stop when being dragged by sudden force, it means it is in proper tightness.
6. Once the testing is completed, *press* the **STOP** button three times to stop the belt.



## 8 Lubrication

Please lubricate the belt on a regular basis. This would prolong the product lifespan by reducing the friction between the belt and the deck and ensure better operational performance. Please lubricate when the mileage reaches 100 km or the word “LUBE” appeared on the screen.

1. Under the “LUBE” window, you will be able to operate the treadmill. Please *press* the **STOP** button to retreat.
2. Turn off the treadmill with the on/off switch and unplug the power cord from the wall outlet.
3. Clean the deck and belt by removing the accumulated dust or hair.
4. Lifted up the side of the belt and applied grease on the deck (please apply it by 30~40 cm along the side of the belt.) Repeat the same procedure on the opposite side.

⚠ To avoid damaging the belt, please apply [Treadmill Silicone Lubricant](#); **DO NOT** apply petroleum-based degreaser.

⚠ Please store the grease in a safe space away from children’s reach.

5. Plug the treadmill in and turn it on. Under standby mode, *press* the **START** button and the Speed   buttons simultaneously to delete the accumulated time and mileage records.
6. *Press* the **START** button to operate the treadmill, and keep the speed between 3~5 km/h. Walk from the upper right side to the lower left side, and the lower left side to the upper right side. Repeat the process several times to evenly apply the silicone lubricant to the deck.
7. *Press* the **STOP** button three times to stop the belt.
8. Turn the power off.
9. Double-check if there is spillage of excessive silicone lubricant on the sides. Wipe down the excess silicone lubricant on the belt or on the sides.

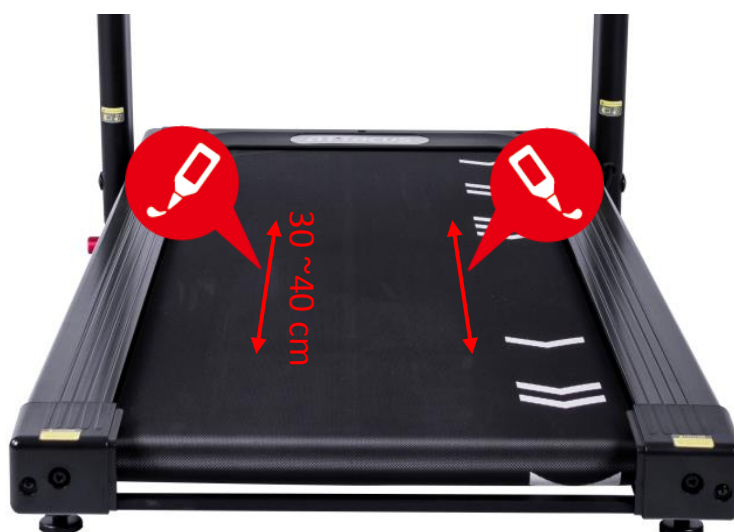

## 9 Specification

Size (L×W×H)	Product: 141×74×123.4 cm / 55.5"×29.1"×48.5" Folding: 33.8×74×141 cm / 13.3"×29.1"×55.5" Packaging: 147×82×29 cm / 57.9"×32.3"×11.4"	
Product Weight	54 kg / 118.8 lb.	
Max. User's Weight	100 kg / 220 lb.	
Running Belt	Running Area: 48×130 cm / 19"×51", Thickness: 1.8mm	
Motor	Continuous 1.5 HP ( Peak 3.0 HP ) / DC Motor	
Power (Optional)	<input type="checkbox"/> 110V, 50Hz	<input type="checkbox"/> 220V-240V AC, 50/60Hz
Screen	8" LCD Backlight LCD	
Ports	USB Output Power×1	
Data Fields	Time, Distance, Steps, Calories, Heart Rate, Pace, Incline, Speed	
Sports Mode	Manual, Random, Cross Country, Weight Loss, Interval 1-1, Interval 2-1, Hill, Target Heart Rate Goal, Fat Burn, Cardio, Heart Rate Hill, Calorie Goal, Distance Goal, Distance Goal 5K, Distance Goal 10K, Custom, etc.	
Heart Rate Monitor	Bluetooth <sup>®</sup> , ANT+ <sup>®</sup> , NFC <sup>™</sup>	
Wireless Technology	Bluetooth Low Energy FTMS Profile	
Application	<a href="#">Ala Fitness App</a> 、 <a href="#">Ala Cloud Run App</a>	
Cloud Integration	<a href="#">GPTfit</a>	
Selective Accessories	<b>ALATECH</b> Heart Rate Chest Strap CS009/CS010/CS011/CS012 <b>ATTACUS</b> Optical Heart Rate Armband Obeat1/Obeat3 <b>ATTACUS</b> GPS Watch Star ONE/Star 2	

After Sale Services (Only applies to Taiwan area)

### **Attacus International**

39F., No.758, Zhongming S. Rd., South Dist., Taichung City 40255, Taiwan (R.O.C.)

Customer Service line: 0800-608341

Operating Hours : Mon.-Fri. 9:30-17:30 (Time may vary on national holidays)

Manufacturer

### **ZHEJIANG ALA FITNESS TECHNOLOGY LTD.**

No.405 Tongxin Road, Tongxiang Economic Development Zone, Zhejiang 314500, CHINA

Tel: +86-573-8862 8666

# 10 Appendix

## 10.1 Exploded View

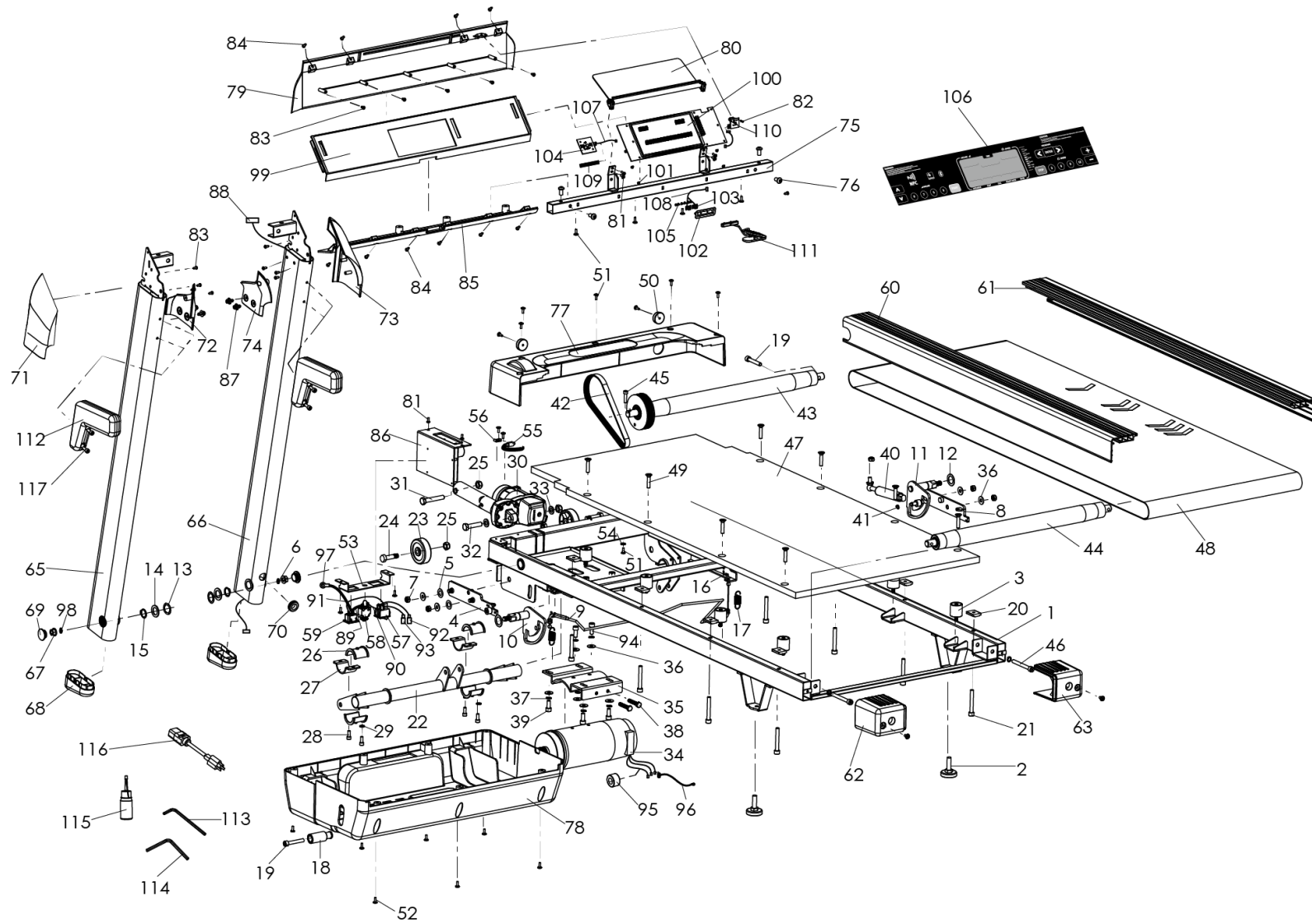



[attacusfitness.com](http://attacusfitness.com)

Designed in Taiwan, made in China.